

CHANGE VERSION	Remarks	C		
A	14/11/24	REL	D	
B			E	

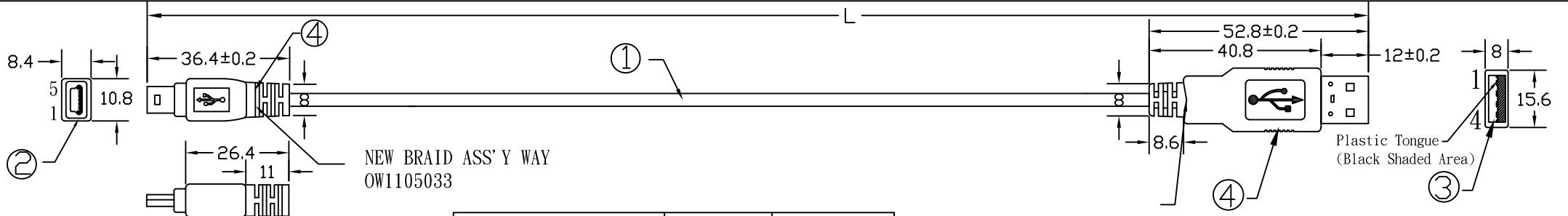

NEW BRAID ASS'Y WAY  
OW1105033

NEW BRAID ASS'Y WAY  
OW1105033

P/N	LENGTH	PE BAG
RR-2MB-240024GHT	610±20	06*4" *6"
RR-2MB-2402-72GHT	1830±50	06*6" *8"
RR-2MB-2402-120GHT	3050±60	06*7" *9"

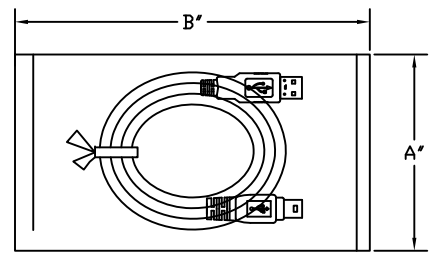
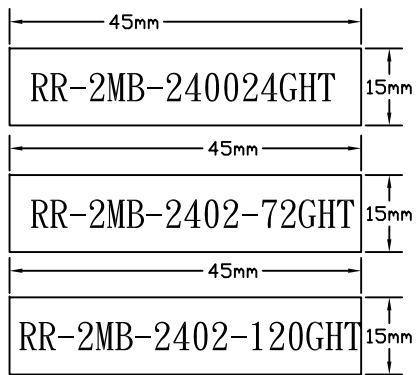
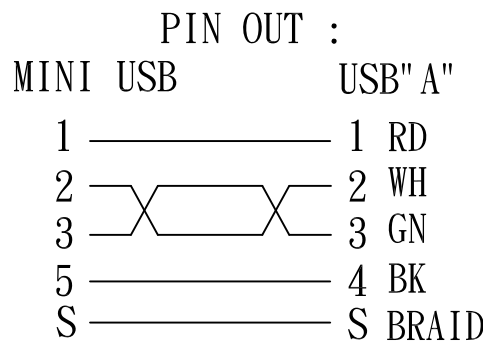

**MATERIAL LIST :**

**P/N STICKER**

NO.	P/NAME	DESCRIPTION	Q' TY
1	WIRE	UL2517 28AWG(7/0.12 TC)*1P+24AWG(7/0.20 TC)*2C+AL+1(TC)+B(16*4/0.10 TC) OD:5.0±0.15 BLACK(B792) (COPARTNER)	1
2	PLUG	MINI USB" B" TYPE 5PIN MALE GOLD PLATED	1
3	PLUG	USB" A" TYPE MALE GOLD PLATED	1
4	PVC	45P BLACK(B792) PVC	12g
5	PACK	1PCE/PE BAG+ P/N STICKER	1

MOLD TOOL NO.
MINI USB A110-536-001
USB" A" A110-160-001

## RoHS



USB FIREWIRE.com

THE INFORMATION CONTAINED HEREIN IS THE PROPRIETARY INFORMATION OF RR BUSINESS VENTURES, LLC. THE POSSESSOR AGREES TO MAINTAIN THIS DOCUMENT IN CONFIDENCE; NOT REPRODUCE IT OR COPY IT, AND NOT TO REVEAL OR PUBLISH IT IN WHOLE OR PART.

COPYRIGHT © 2019

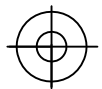
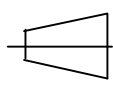
		SCALE	UNIT	REV
		MM		A
FILE NAME		CUSTOMER		
OW1411018				
DATE		CUSTOMER P/N		
14/11/24				

DRAWN BY

Marcos

CHECKED BY

---

CHECKED BY

---

CHECKED BY

---

APPROVED BY